

LH0021/LH0021C 1.0 Amp Power Operational Amplifier
LH0041/LH0041C 0.2 Amp Power Operational Amplifier

General Description

The LH0021/LH0021C and LH0041/LH0041C are general purpose operational amplifiers capable of delivering large output currents not usually associated with conventional IC Op Amps. The LH0021 will provide output currents in excess of one ampere at voltage levels of $\pm 12V$; the LH0041 delivers currents of 200 mA at voltage levels closely approaching the available power supplies. In addition, both the inputs and outputs are protected against overload. The devices are compensated with a single external capacitor and are free of any unusual oscillation or latch-up problems.

- High slew rate 3.0V/ μ s
- High open loop gain 100 dB

The excellent input characteristics and high output capability of the LH0021 make it an ideal choice for power applications such as DC servos, capstan drivers, deflection yoke drivers, and programmable power supplies.

The LH0041 is particularly suited for applications such as torque driver for inertial guidance systems, diddle yoke driver for alpha-numeric CRT displays, cable drivers, and programmable power supplies for automatic test equipment.

The LH0021 is supplied in a 8 pin TO-3 package rated at 20 watts with suitable heatsink. The LH0041 is supplied in both 12 pin TO-8 (2.5 watts with clip on heatsink) and a power 8 pin ceramic DIP (2 watts with suitable heatsink). The LH0021 and LH0041 are guaranteed over the temperature range of $-55^{\circ}C$ to $+125^{\circ}C$ while the LH0021C and LH0041C are guaranteed from $-25^{\circ}C$ to $+85^{\circ}C$.

Features

- Output current 1.0 Amp (LH0021)
0.2 Amp (LH0041)
- Output voltage swing $\pm 12V$ into 10Ω (LH0021)
 $\pm 14V$ into 100Ω (LH0041)
- Wide full power bandwidth 15 kHz
- Low standby power 100 mW at $\pm 15V$
- Low input offset voltage and current 1 mV and 20 nA

Schematic and Connection Diagrams

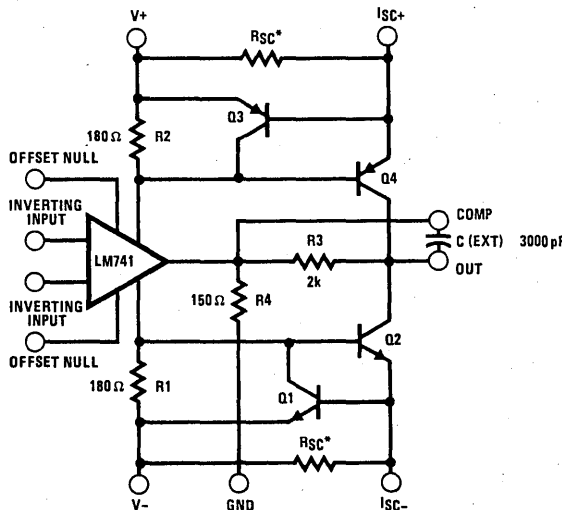

*Rsc external on "G" and "K" packages. Rsc internal on "J" package. Offset Null connections available only on "G" package.

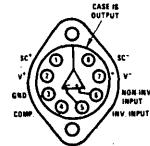

Order Number
LH0021K or LH0021CK
See Package K08A

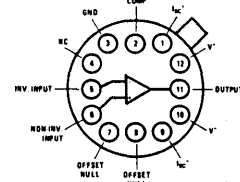

Order Number
LH0041G or LH0041CG
See Package H12B

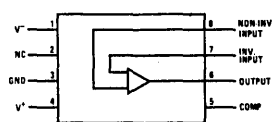

Order Number
LH0041CJ
See Package HY08A

Absolute Maximum Ratings

Supply Voltage	±18V
Power Dissipation	See curves
Differential Input Voltage	±30V
Input Voltage (Note 1)	±15V
Peak Output Current (Note 2)	LH0021/LH0021C 2.0 Amps
	LH0041/LH0041C 0.5 Amps
Output Short Circuit Duration (Note 3)	Continuous
Operating Temperature Range	LH0021/LH0041 -55°C to +125°C
	LH0021C/LH0041C -25°C to +85°C
Storage Temperature Range	-65°C to +150°C
Lead Temperature (Soldering, 10 sec)	300°C

1

LH0021/LH0021C, LH0041/LH0041C

DC Electrical Characteristics for LH0021/LH0021C (Note 4)

PARAMETER	CONDITIONS	LIMITS						UNITS
		LH0021			LH0021C			
		MIN	TYP	MAX	MIN	TYP	MAX	
Input Offset Voltage	$R_S \leq 100\Omega, T_C = 25^\circ\text{C}$		1.0	3.0		3.0	6.0	mV
	$R_S \leq 100\Omega$			5.0			7.5	mV
Voltage Drift with Temperature	$R_S \leq 100\Omega$		3	25		5	30	$\mu\text{V}/^\circ\text{C}$
Offset Voltage Drift with Time			5			5		$\mu\text{V}/\text{week}$
Offset Voltage Change with Output Power			5	15		5	20	$\mu\text{V}/\text{watt}$
Input Offset Current	$T_C = 25^\circ\text{C}$		30	100		50	200	nA
				300			500	nA
Offset Current Drift with Temperature			0.1	1.0		0.2	1.0	$\text{nA}/^\circ\text{C}$
Offset Current Drift with Time			2			2		nA/week
Input Bias Current	$T_C = 25^\circ\text{C}$		100	300		200	500	nA
				1.0			1.0	μA
Input Resistance	$T_C = 25^\circ\text{C}$	0.3	1.0		0.3	1.0		M Ω
Input Capacitance			3			3		pF
Common Mode Rejection Ratio	$R_S \leq 100\Omega, \Delta V_{CM} = \pm 10\text{V}$	70	90		70	90		dB
Input Voltage Range	$V_S = \pm 15\text{V}$	±12			±12			V
Power Supply Rejection Ratio	$R_S \leq 100\Omega, \Delta V_S = \pm 10\text{V}$	80	96		70	90		dB
Voltage Gain	$V_S = \pm 15\text{V}, V_O = \pm 10\text{V}$ $R_L = 1\text{ k}\Omega, T_C = 25^\circ\text{C}$	100	200		100	200		V/mV
	$V_S = \pm 15\text{V}, V_O = \pm 10\text{V}$ $R_L = 100\Omega$	25			20			V/mV
Output Voltage Swing	$V_S = \pm 15\text{V}, R_L = 100\Omega$	±13.5	14		±13	±14		V
	$V_S = \pm 15\text{V}, R_L = 10\Omega, T_C = 25^\circ\text{C}$	±11.0	±12		±10	±12		V
Output Short Circuit Current	$V_S = \pm 15\text{V}, T_C = 25^\circ\text{C}, R_{SC} = 0.5\Omega$	0.8	1.2	1.6	0.8	1.2	1.6	Amps
Power Supply Current	$V_S = \pm 15\text{V}, V_{OUT} = 0$		2.5	3.5		3.0	4.0	mA
Power Consumption	$V_S = \pm 15\text{V}, V_{OUT} = 0$		75	105		90	120	mW

AC Electrical Characteristics for LH0021/LH0021C ($T_A = 25^\circ\text{C}, V_S = \pm 15\text{V}, C_C = 3000\text{pF}$)

Slew Rate	$A_v = +1, R_L = 100\Omega$	0.8	3.0		1.0	3.0		V/ μs
Power Bandwidth	$R_L = 100\Omega$		20			20		kHz
Small Signal Transient Response			0.3	1.0		0.3	1.5	μs
Small Signal Overshoot			5	20		10	30	%
Settling Time (0.1%)	$\Delta V_{IN} = 10\text{V}, A_v = +1$		4			4		μs
Overload Recovery Time			3			3		μs
Harmonic Distortion	$f = 1\text{ kHz}, P_O = 0.5\text{W}$		0.2			0.2		%
Input Noise Voltage	$R_C = 50\Omega, \text{B.W.} = 10\text{ Hz to } 10\text{ kHz}$		5			5		$\mu\text{V rms}$
Input Noise Current	$\text{B.W.} = 10\text{ Hz to } 10\text{ kHz}$		0.05			0.05		nA rms

DC Electrical Characteristics for LH0041/LH0041C (Note 4)

PARAMETER	CONDITIONS	LIMITS						UNITS
		LH0041			LH0041C			
		MIN	TYP	MAX	MIN	TYP	MAX	
Input Offset Voltage	$R_S < 100\Omega, T_A = 25^\circ\text{C}$		1.0	3.0		3.0	6.0	mV
	$R_S < 100\Omega$			5.0			7.5	mV
Voltage Drift with Temperature	$R_S < 100\Omega$		3			5		$\mu\text{V}/^\circ\text{C}$
Offset Voltage Drift with Time			5			5		$\mu\text{V}/\text{week}$
Offset Voltage Change with Output Power			15			15		$\mu\text{V}/\text{watt}$
Offset Voltage Adjustment Range	(Note 5)		20			20		mV
Input Offset Current	$T_A = 25^\circ\text{C}$		30	100		50	200	nA
				300			500	nA
Offset Current Drift with Temperature			0.1	1.0		0.2	1.0	$\text{nA}/^\circ\text{C}$
Offset Current Drift with Time			2			2		nA/week
Input Bias Current	$T_A = 25^\circ\text{C}$		100	300		200	500	nA
				1.0			1.0	μA
Input Resistance	$T_A = 25^\circ\text{C}$	0.3	1.0		0.3	1.0		M Ω
Input Capacitance			3			3		pF
Common Mode Rejection Ratio	$R_S < 100\Omega, \Delta V_{\text{CM}} = \pm 10\text{V}$	70	90		70	90		dB
Input Voltage Range	$V_S = \pm 15\text{V}$	+12			+12			V
Power Supply Rejection Ratio	$R_S < 100\Omega, \Delta V_S = \pm 10\text{V}$	80	96		70	90		dB
Voltage Gain	$V_S = \pm 15\text{V}, V_O = \pm 10\text{V}$ $R_L = 1\text{ k}\Omega, T_A = 25^\circ\text{C}$ $V_S = \pm 15\text{V}, V_O = \pm 10\text{V}$ $R_L = 100\Omega$	100	200		100	200		V/mV
		25			20			V/mV
Output Voltage Swing	$V_S = \pm 15\text{V}, R_L = 100\Omega$	+13.0	14.0		+13.0	+14.0		V
Output Short Circuit Current	$V_S = \pm 15\text{V}, T_A = 25^\circ\text{C}$ (Note 6)		200	300		200	300	mA
Power Supply Current	$V_S = \pm 15\text{V}, V_{\text{OUT}} = 0$		2.5	3.5		3.0	4.0	mA
Power Consumption	$V_S = \pm 15\text{V}, V_{\text{OUT}} = 0$		75	105		90	120	mW

AC Electrical Characteristics for LH0041/LH0041C ($T_A = 25^\circ\text{C}, V_S = \pm 15\text{V}, C_C = 3000\text{ pF}$)

Slew Rate	$A_V = +1, R_L = 100\Omega$	1.5	3.0		1.0	3.0		V/ μs
Power Bandwidth	$R_L = 100\Omega$		20			20		kHz
Small Signal Transient Response			0.3	1.0		0.3	1.5	μs
Small Signal Overshoot			5	20		10	30	%
Settling Time (0.1%)	$\Delta V_{\text{IN}} = 10\text{V}, A_V = +1$		4			4		μs
Overload Recovery Time			3			3		μs
Harmonic Distortion	$f = 1\text{ kHz}, P_O = 0.5\text{W}$		0.2			0.2		%
Input Noise Voltage	$R_S = 50\Omega, \text{B.W.} = 10\text{ Hz to } 10\text{ kHz}$		5			5		$\mu\text{V}/\text{rms}$
Input Noise Current	$\text{B.W.} = 10\text{ Hz to } 10\text{ kHz}$		0.05			0.05		nA/rms

Note 1: Rating applies for supply voltages above $\pm 15\text{V}$. For supplies less than $\pm 15\text{V}$, rating is equal to supply voltage.

Note 2: Rating applies for LH0041G and LH0021K with $R_{\text{SC}} = 0\Omega$.

Note 3: Rating applies as long as package power rating is not exceeded.

Note 4: Specifications apply for $\pm 5\text{V} \leq V_S \leq \pm 18\text{V}$, and $-55^\circ\text{C} \leq T_C \leq 125^\circ\text{C}$ for LH0021K and LH0041G, and $-25^\circ\text{C} \leq T_C \leq +85^\circ\text{C}$ for LH0021CK, LH0041CG and LH0041CJ unless otherwise specified. Typical values are for 25°C only.

Note 5: TO-8 "G" packages only.

Note 6: Rating applies for "J" DIP package and for TO-8 "G" package with $R_{\text{SC}} = 3.3\text{ ohms}$.

Typical Performance Characteristics

1

LH0021/LH0021C, LH0041/LH0041C

Power Derating-LH0021

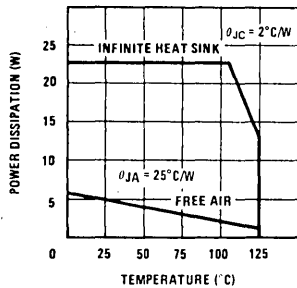

Safe Operating Area - LH0021

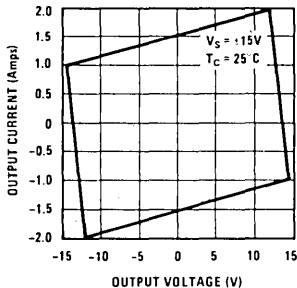

Package Power Dissipation LH0041/LH0041C

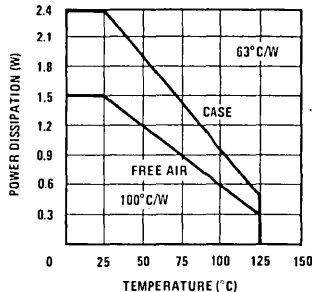

Output Voltage Swing

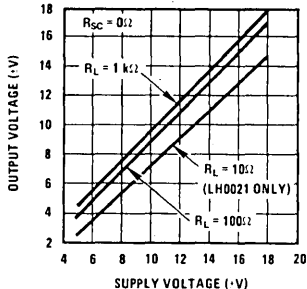

Open Loop Frequency Response

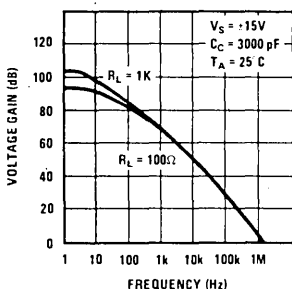

Large Signal Frequency Response

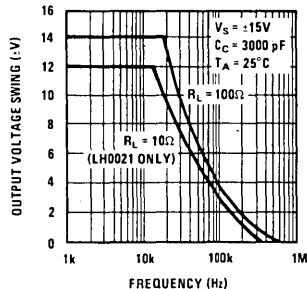

Voltage Follower Pulse Response

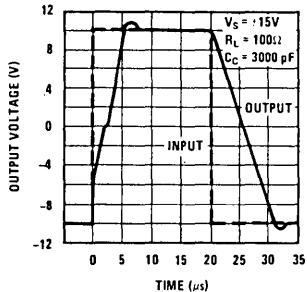

No Load Supply Current

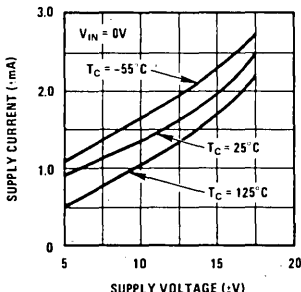

Short Circuit Current vs Temperature LH0021/LH0021C

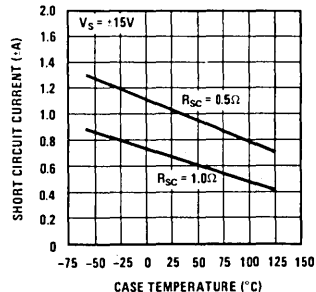

Short Circuit Current vs Temperature LH0041/LH0041C

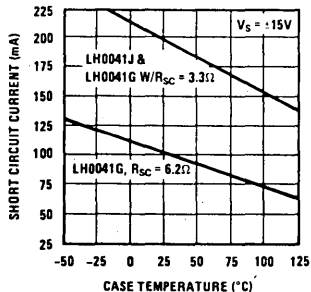

Input Bias Current

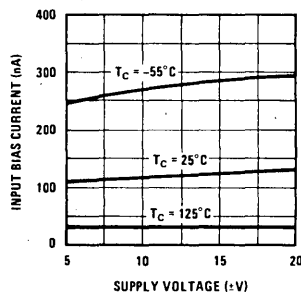

Voltage Gain

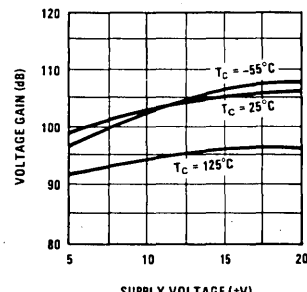

Typical Performance Characteristics (Cont'd)

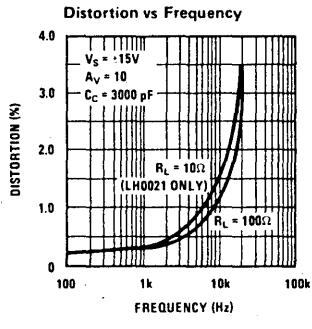
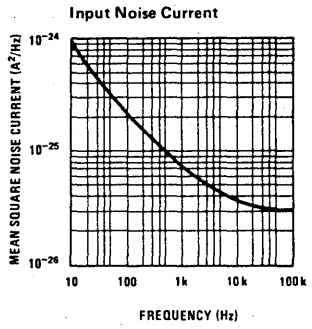
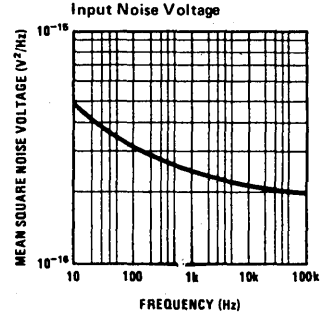
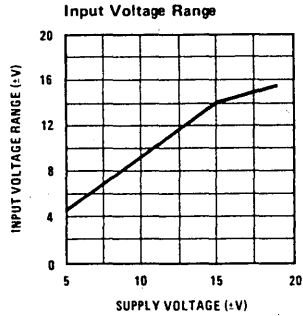
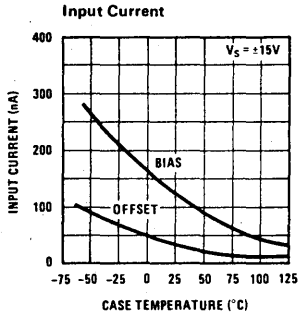

Typical Applications

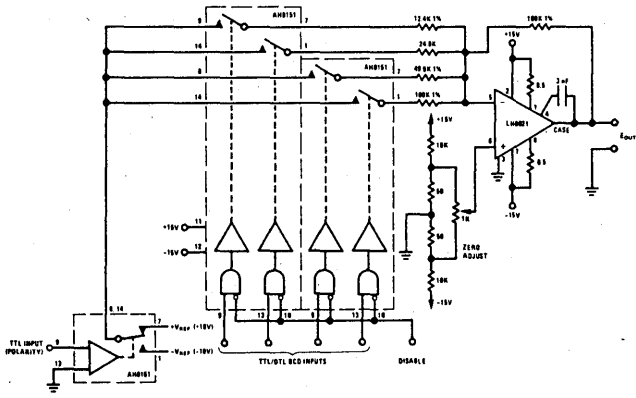

Programmable One Amp Power Supply

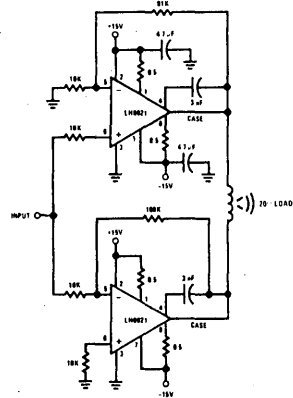

10 WATT (rms) Audio Amplifier

Typical Applications (Cont'd)

1

LH0021/LH0021C, LH0041/LH0041C

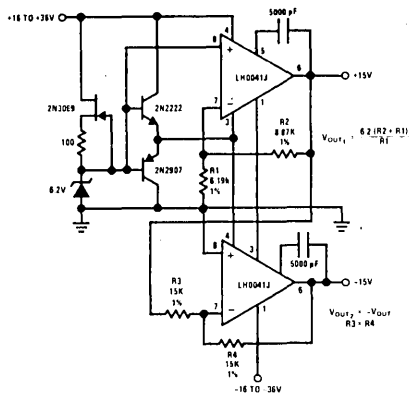

Dual Tracking One Amp Power Supply

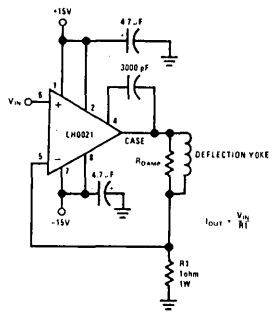

CRT Deflection Yoke Driver

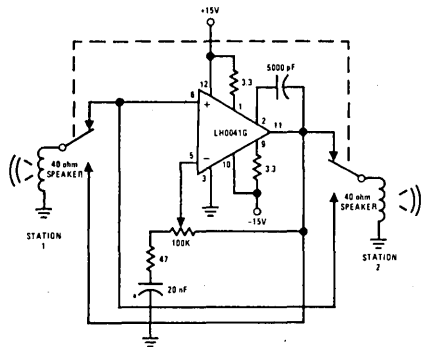

Two Way Intercom

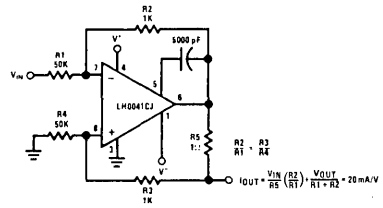

Programmable High Current Source/Sink

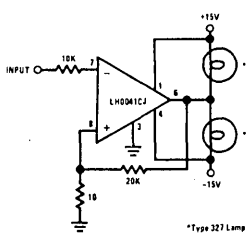

Power Comparator

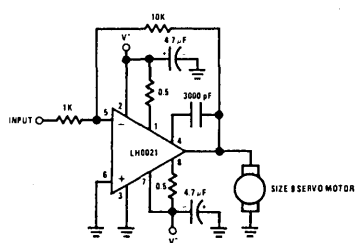

DC Servo Amplifier

Auxiliary Circuits

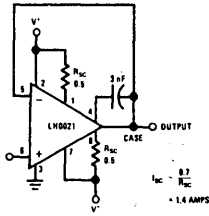

LH0021 Unity Gain Circuit with Short Circuit Limiting

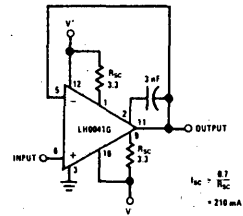

LH0041G Unity Gain with Short Circuit Limiting

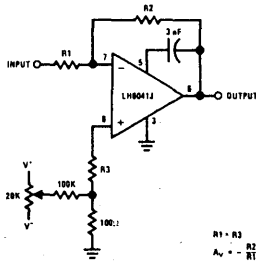

LH0041/LH0021 Offset Voltage Null Circuit (LH0041CJ Pin Connections Shown)*

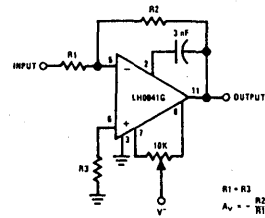

LH0041G Offset Voltage Null Circuit*

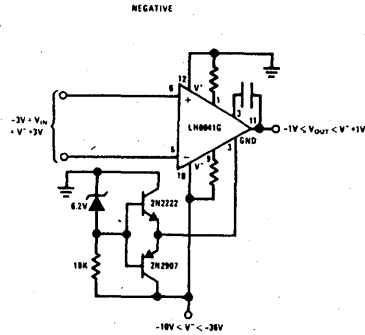
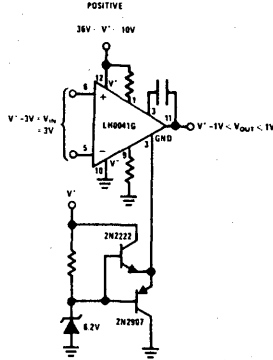

Operation from Single Supplies

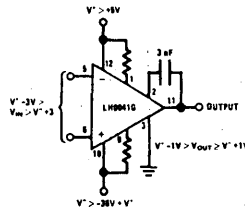
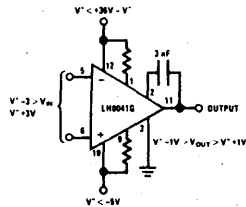

Operation from Non-Symmetrical Supplies

*For additional offset null circuit techniques see National Linear Applications Handbook.